

TOWER MODEL	T-135
TOWER CONSTRUCTION	3 12FT SECTIONS
NUMBER OF SECTION	3
TOWER SECTIONS	A, B, C
LENGTH OF EACH SECTION	12 FT
MAXIMUM HEIGHT W/ MAST	32 FT
NESTED HEIGHT W/O MAST	12 FT 9 IN
WIDTH OF UNIT	16 IN
RAISING SYSTEM	WORM GEAR WINCH
TYPE OF BASE	T
APPROXIMATE WEIGHT	74 LBS
MAXIMUM PAY LOAD	50 LBS
MAXIMUM WIND LOAD	5 SQ. FT.
MAXIMUM WIND	70 MPH

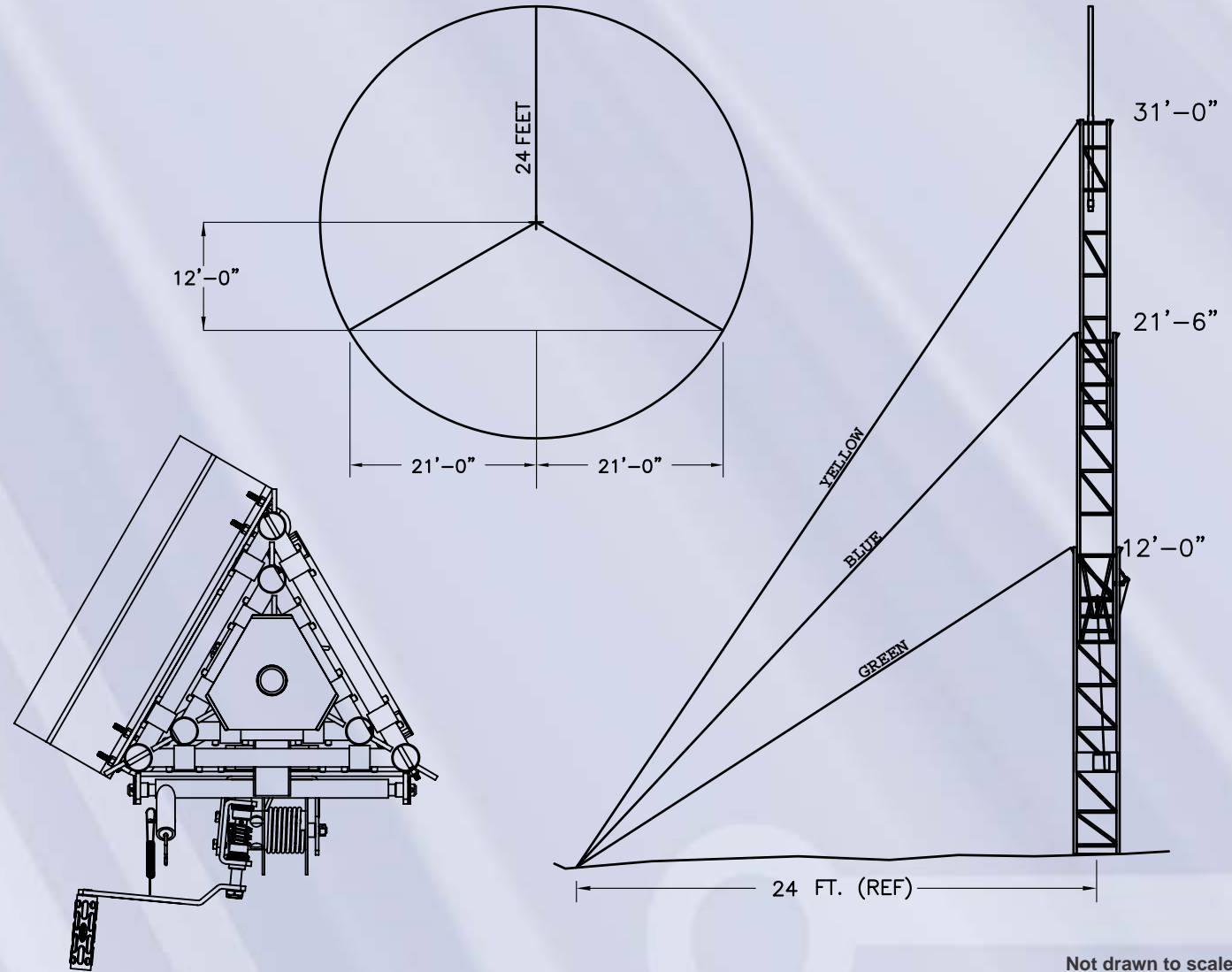
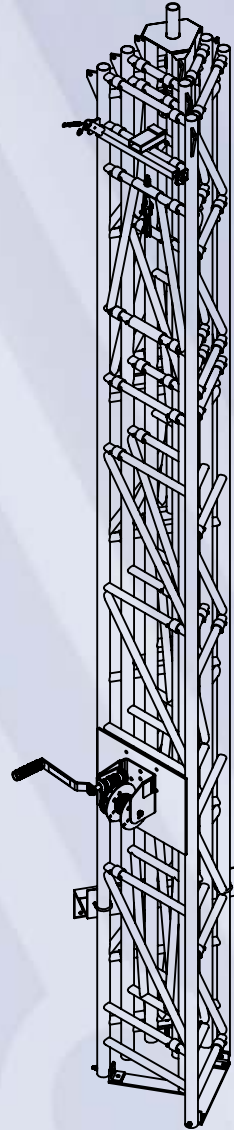

Not drawn to scale.
All Tower numbers are based on proper guyed installation conditions. See installation manual for directions.
Aluma Tower Company, Inc. reserves the right to make changes at any time to information contained in this document.